

1 Entoure le dessin quand tu entends « é »

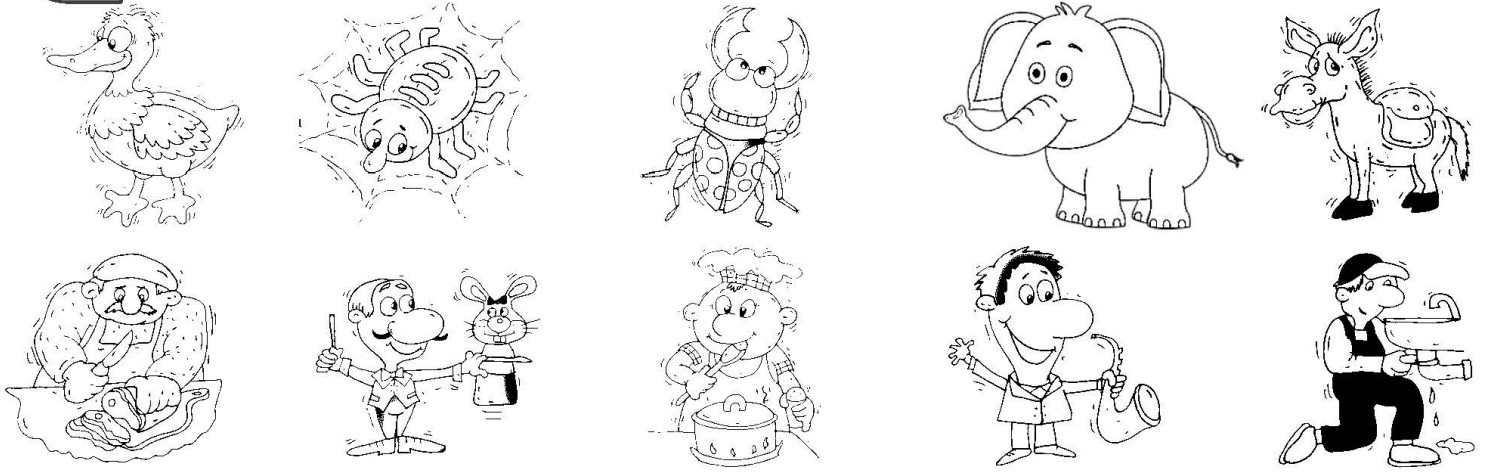

2 Fais une croix où tu entends « é »

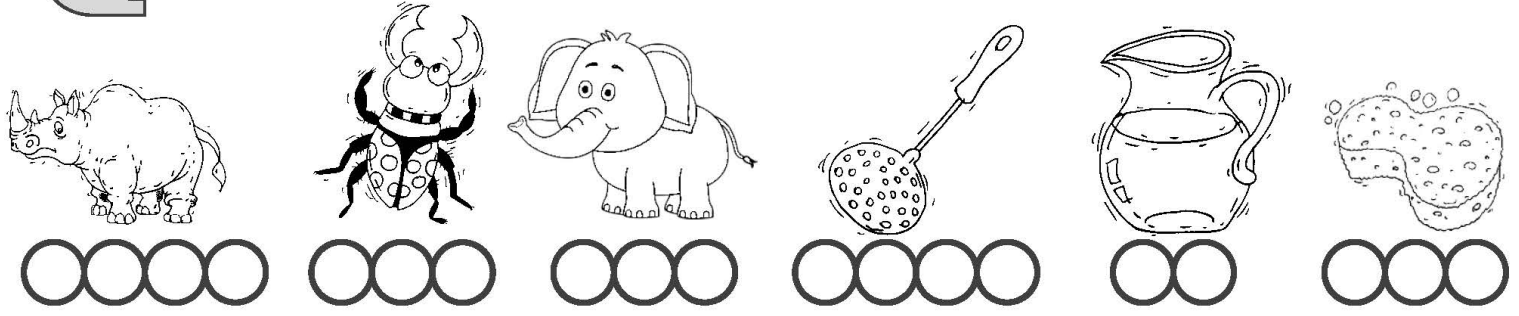

3 Entoure les « é »

É è é e È e É ê é è E é é è
 e é è é ê é é è è é

4 Ecris é quand tu entends « é »

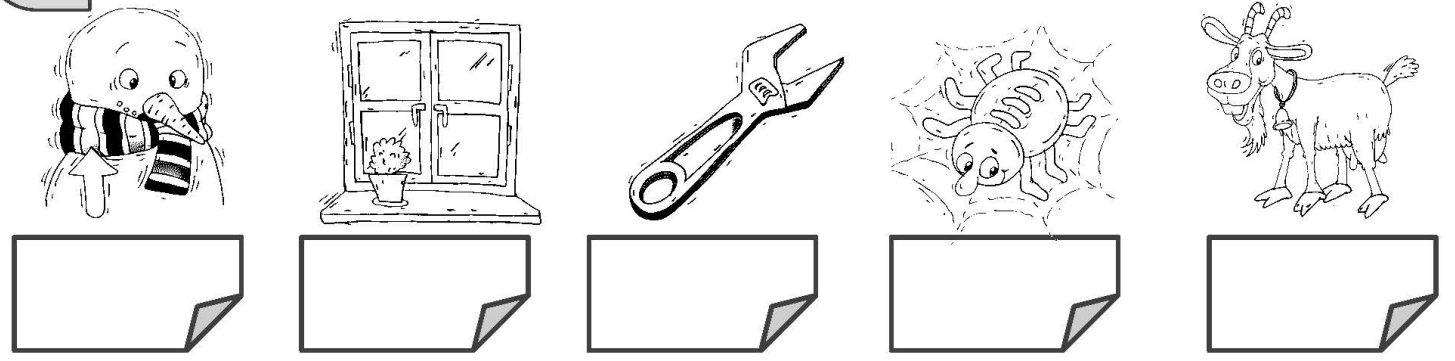

1 Entoure le dessin quand tu entends « e »

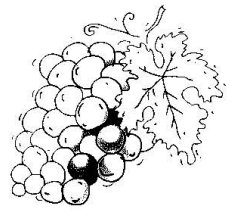
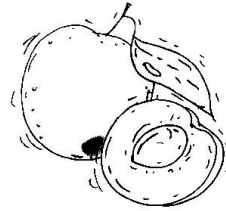
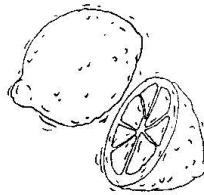
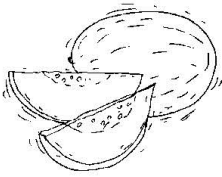
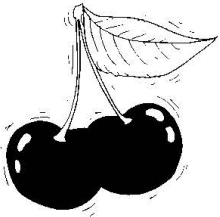
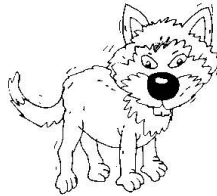
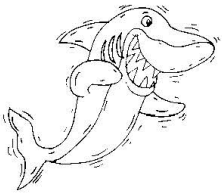

2 Fais une croix où tu entends « e »

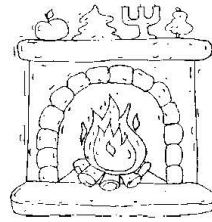
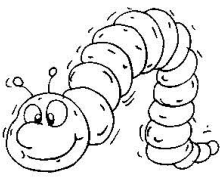
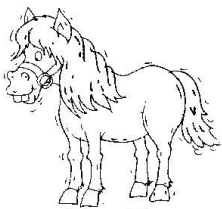

3 Entoure les « e »

e a i o u E e I O W E e i a é

i a o e o W i e e a o

4 Ecris e quand tu entends « e »

